



Item	RA-105A XXL TROLLEY
------	----------------------------

Description	Size:	L 79 3/5	x	W 36 1/5	x	H 45 2/7	inch
		L 202,18	x	W 91,95	x	H 115,06	cm
<p>Trolley with folding handle. Extractable vertical posts around the trolley in order to immobilize the stacked tables.</p> <p>Wheels with individual brakes.</p> <p>Capacity: 30 pcs. XXL3, 15pcs XXL4.5 or 15pcs XXL6</p> <p>Handle, Steel tube: 1-1/8"x1.8mm - 28,57x 1,00 mm</p> <p>Base Frame & Square Steel Tube: 38x38x1.5mm</p> <p>Triangle Steel Plate: Thickness 4mm</p>							
							

Package	Carton size:	L 83 3/4	x	W 40	x	H 6	inch	Vol. (m³)	0,3294
		L 212,73	x	W 101,60	x	H 15,24	cm		
Pcs/ctn	1 pcs/ctn						EAN	8437009886069	
Net weight	30,24 Kg		66,53 lb		40'CY		198		
Gross weight	35,24 Kg		77,53 lb		40'HQ		210		

Remarks:





Capacity: 30 pcs XXL3

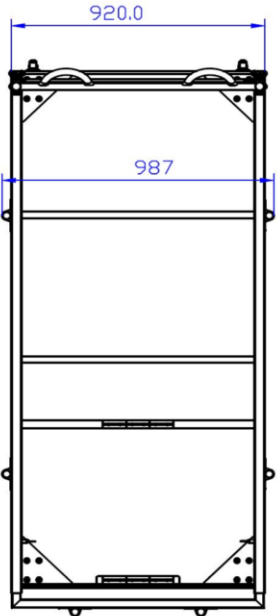

Part to hold the removable posts when folded. Bar with automatic unlocking mechanism which allows the vertical bracket to be folded. Trolley in fully folded position. Occupies a minimum of space.

All parts are integrated to prevent loss.





Capacity: 15 pcs XXL4.5



4 polyurethane wheels with integrated brake. (Two fixed wheels and two pivoting wheels).



Capacity: 15 pcs XXL6

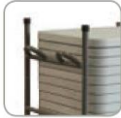

Handle specially designed to protect the hands.